

Installation Instructions

IS-86627_RevA



Trail Can Mount

For proper installation and best possible fit, please read all instructions BEFORE you begin.
For technical assistance or to obtain missing parts, please call Customer Relations at 1-800-328-2409.

Important Safety Information



- CAUTION - Before driving, ensure that the part is properly secured to vehicle.
- Periodically check all components for tightness.

Contents

NOTE: Actual product may vary from illustration.

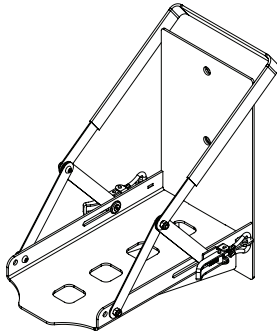

Trail Can Mount

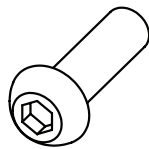

12mm Allen Head Bolt (3)



12mm Nylock Nuts (3)

Tools Required



Allen Wrench Set



Wrench Set

Installation

1

Bolt the Trail Can Mount onto the Accessory Panel built into the Rampage Swing Away Tire Carrier using the (3) provided 12mm Allen Head Bolts and Nylock Washers.

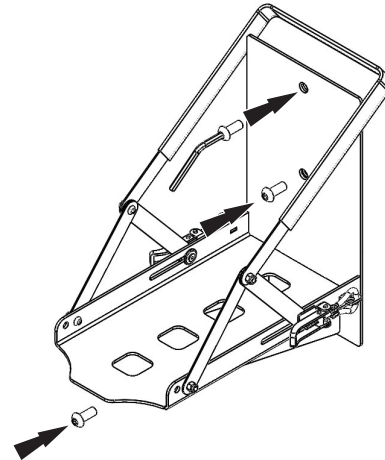

2

Pivot the hold down strap away from the Jeep and towards the ground. Then place the Trail Can or Gerry Can on the Mount.

Raise the hold down strap towards the Jeep and adjust the strap so that it rests between the handle and the lock mechanism.

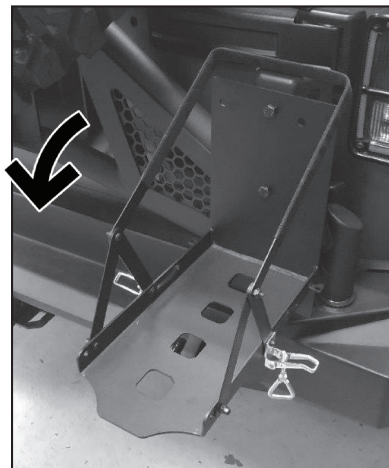

3

Adjust the rear leg of the hold down strap as far towards the back of the mount as possible.

Adjust the clamps by rotating the triangle eye bolt. Then pull the clamp lever back, flush with the Trail Can Mount.

Take care not to over tighten the clamps and damage the hold down strap.

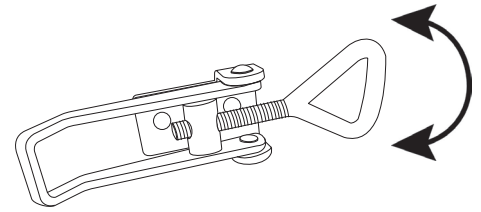

4

The tab for the clamp is designed so a lock can be used to secure the Trail Can to the vehicle.

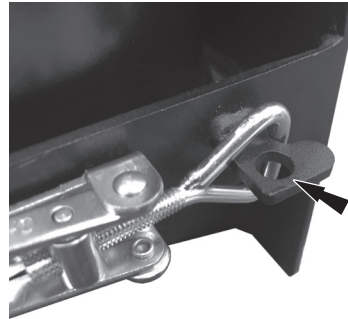

3

Periodically check hardware and clamps for tightness.

Care and Cleaning

- Rampage Trail Can Mounts are built to last; any detergent you use to wash your vehicle is sufficient to clean the bumper. Do not use any harsh abrasive detergents. Periodically check and lubricate moving parts, tire swing pivot has a zerk fitting to grease joint.

Congratulations!

You have purchased one of the many quality Rampage™ branded products offered by Lund International. We take the utmost pride in our products and want you to enjoy years of satisfaction from your investment. We have made every effort to ensure that your product is top quality in terms of fit, durability, finish and ease of installation.



The material that your product is made from can be recycled. Please also consider recycling the packaging that your product came in.



800-328-2409 • Visit us at Rampageproducts.com
© 2018 Lund Motion Products, Inc. All rights reserved.
Rampage Products™ is a trademark of Lund Motion Products, Inc.



Instructions d'installation

IS-86627_RevA



Sentier peut monter

Pour une installation correcte et un ajustement optimal, veuillez lire toutes les instructions AVANT de commencer.
Pour obtenir une assistance technique ou obtenir des pièces manquantes, veuillez appeler le service à la clientèle au 1-800-328-2409.

Informations de sécurité importantes



- ATTENTION - Avant de prendre la route, assurez-vous que la pièce est correctement fixée au véhicule.
- Vérifiez périodiquement l'étanchéité de tous les composants.

Contenu

REMARQUE: le produit réel peut différer de l'illustration.

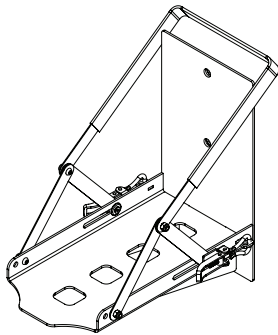

Sentier peut monter

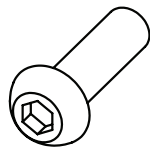

Boulon à tête hexagonale de 12 mm (3)

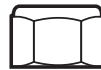

Écrous Nylock 12mm (3)

Outils nécessaires



Jeu de clés Allen

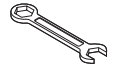

Jeu de clés

Installation

1

Fixez le support de remorque sur le panneau d'accessoires intégré au porte-pneus Rampage à l'aide des (3) boulons à tête Allen et des rondelles Nylock de 12 mm fournies.

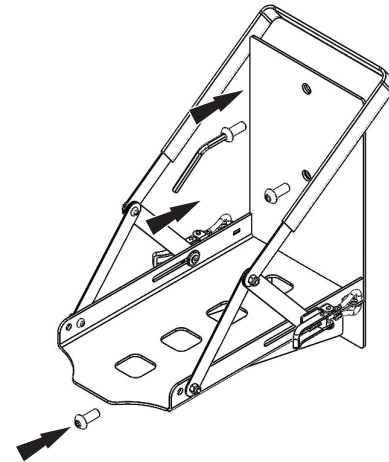

2

Faites pivoter la sangle de maintien de la Jeep vers le sol. Placez ensuite le Trail Can ou le Gerry Can sur le support.

Soulevez la sangle de maintien vers le Jeep et réglez-la de sorte qu'elle repose entre la poignée et le mécanisme de verrouillage.

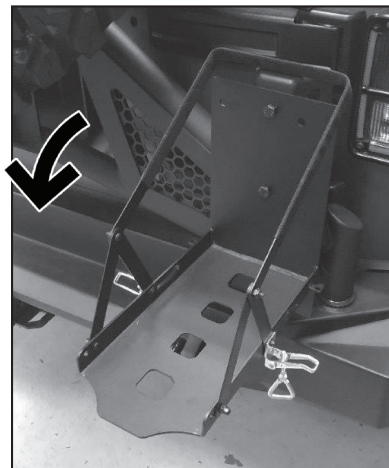

3 Ajustez le pied arrière de la sangle de maintien le plus loin possible vers l'arrière du support.

Ajustez les pinces en tournant le boulon à oeil triangulaire. Ensuite, tirez le levier de serrage vers l'arrière pour l'aligner avec le support de fixation pour boîtier de piste.

Veillez à ne pas trop serrer les pinces et à ne pas endommager la sangle de maintien.

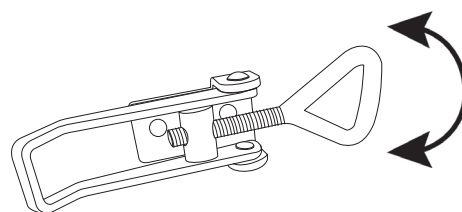

4 La languette de la pince est conçue pour pouvoir utiliser un verrou pour fixer le Trail Can au véhicule.

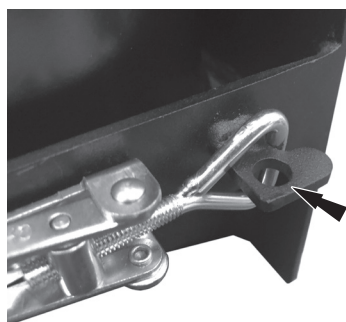

3 Vérifiez périodiquement le matériel et les pinces.

Entretien et nettoyage

- Rampage Sentier construits pour durer; le détergent que vous utilisez pour laver votre véhicule suffit à nettoyer le pare-chocs. N'utilisez pas de détergents abrasifs puissants. Vérifiez périodiquement et lubrifiez les pièces mobiles. Le pivot de pivotement du pneu est doté d'un raccord zerk pour graisser le joint.

Félicitations!

Vous avez acheté l'un des nombreux produits de marque Rampage™ proposés par Lund International. Nous sommes très fiers de nos produits et souhaitons que vous profitiez de votre investissement pendant des années. Nous avons fait tous les efforts pour que votre produit soit de la meilleure qualité en termes d'ajustement, de durabilité, de finition et de facilité d'installation.



Le matériau de votre produit peut être recyclé. Veuillez également envisager de recycler l'emballage dans lequel votre produit est entré.



800-328-2409 • Rendez-nous visite à Rampageproducts.com

© 2018 Lund Motion Products, Inc. Tous droits réservés.



Rampage Products™ est une marque commerciale de Lund Motion Products, Inc.



Instrucciones de instalación

IS-86627_RevA



Sendero puede montar

Para una instalación adecuada y el mejor ajuste posible, lea todas las instrucciones ANTES de comenzar.
Para obtener asistencia técnica o para obtener piezas faltantes, llame a Atención al Cliente al 1-800-328-2409.

Información de Seguridad Importante



- PRECAUCIÓN: antes de conducir, asegúrese de que la pieza esté bien sujeta al vehículo.
- Verifique periódicamente que todos los componentes estén apretados.

Contents

NOTA: El producto real puede variar de la ilustración.

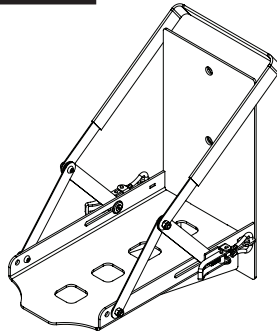

Sendero puede montar

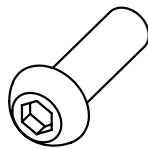

Perno de cabeza Allen de 12 mm (3)



Tuercas Nylock de 12 mm (3)

Tools Required



Juego de llaves Allen

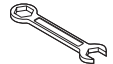

Juego de llaves

Instalación

1

Atornille el Trail Can Mount en el panel de accesorios integrado en el portador de neumáticos Rampage Swing Away utilizando los (3) tornillos de cabeza Allen de 12 mm y arandelas Nylock provistos.

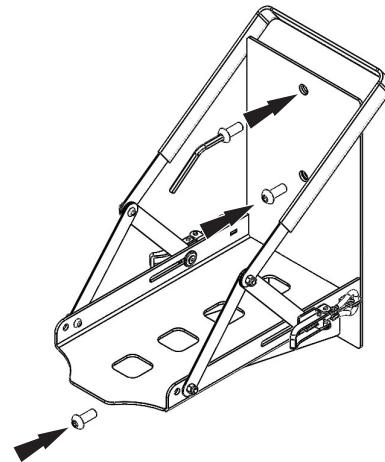

2

Gire la correa de sujeción alejándola del Jeep y hacia el suelo. Luego coloque el Trail Can o Gerry Can en el soporte.

Levante la correa de sujeción hacia el jeep y ajuste la correa de modo que quede entre el asa y el mecanismo de bloqueo.

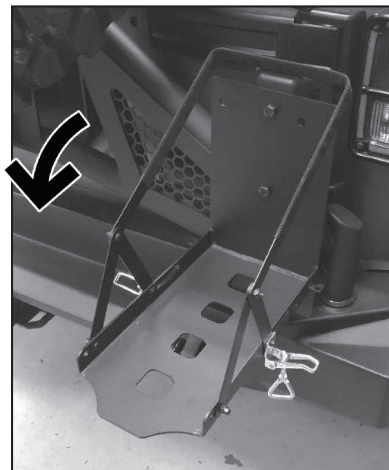

3 Ajuste la pata trasera de la correa de sujeción tan lejos como sea posible hacia la parte posterior del soporte.

Ajuste las abrazaderas girando el perno de ojo de triángulo. Luego, tire de la palanca de sujeción hacia atrás, al ras con el Trail Can Mount.

Tenga cuidado de no apretar demasiado las abrazaderas y dañar la correa de sujeción.

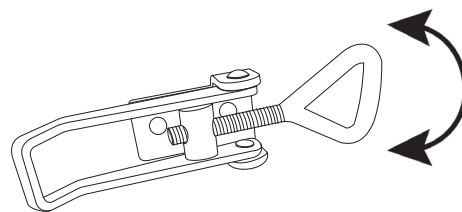
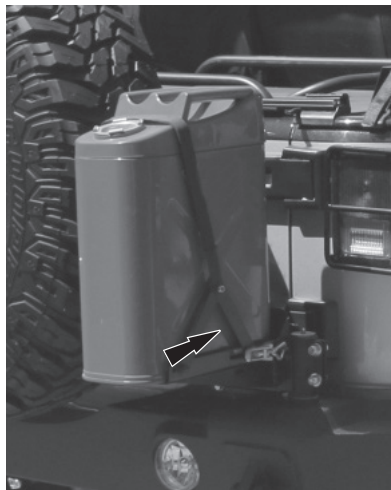

4 La pestaña de la abrazadera está diseñada para que se pueda usar un candado para asegurar el Trail Can al vehículo.

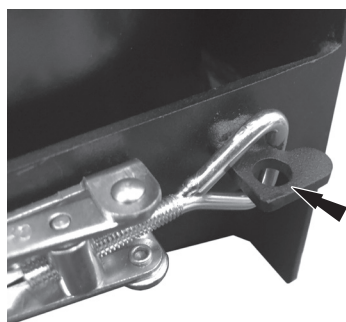

3 Revise periódicamente los herrajes y las abrazaderas para comprobar si están apretados.

Cuidado y Limpieza

- Rampage Sendero puede montar se construyen para durar; Cualquier detergente que use para lavar su vehículo es suficiente para limpiar el parachoques. No utilice detergentes abrasivos fuertes. Revise y lubrique periódicamente las piezas móviles, el pivote de giro del neumático tiene un accesorio zerk para engrasar la junta.

¡Felicidades!

Ha comprado uno de los muchos productos de calidad de marca Rampage™ ofrecidos por Lund International. Nos enorgullecemos de nuestros productos y deseamos que disfrute de años de satisfacción con su inversión. Hemos hecho todos los esfuerzos posibles para garantizar que su producto sea de la mejor calidad en términos de ajuste, durabilidad, acabado y facilidad de instalación.



El material del que está hecho su producto puede ser reciclado. Por favor, también considere reciclar el empaque que recibió su producto.



800-328-2409 • Visítenos en Rampageproducts.com
© 2018 Lund Motion Products, Inc. Todos los derechos reservados.
Rampage Products™ es una marca registrada de Lund Motion Products, Inc.

